

## RICERCA E INNOVAZIONE

### RESEARCH AND INNOVATION

IT

Il mercato ricerca sempre di più i prodotti fonoassorbenti per l'uso in ambienti quali ristoranti, lounge aeroportuali, biblioteche, social clubs, hotel lobby oltre che in un ambiente ufficio. Il Centro Studi e Ricerche della Steelbox ha rinnovato il design di ZEN, proponendo un pannello che si adatta anche in spazi dove il design non è solo una mera alternativa, ma una necessità.

Il Pannello fono-dinamico Zen, concepito con una nuova estetica che richiama vagamente il famoso design capitonné, alleggerisce le linee rendendole meno piatte senza sacrificarne l'eleganza e la leggerezza del materiale.

Oltre al design, anche le performance di assorbimento acustico sono state migliorate, grazie alle cavità coniche sulla superficie, che esercitano azione di risonatori; le vibrazioni sono infatti catturate in misura maggiore e il suono rilasciato più lentamente, provocando un aumento di assorbimento rispetto alla precedente versione del pannello ZEN.

EN

The latest market research reveals the growing request for Acoustic Products to be used in different environment such as restaurants, airport lounges, libraries, social clubs, hotel lobbies as well as the office environment. Our R&D department has renewed the design of Zen, proposing a new panel decoration to ease and redefine the application in environments where the design is not just another option, it's a need.

The fono-dynamic Zen Panel has a brand new aestetich that recalls the famous design capitonné, while bringing elegance to the product it exalts the lightness of the material, reducing the flatness of the surface.

Beside the design, the performances of sound absorption have been improved, due to the conical cavity on the surface, acting like resonate rings; the vibration are being mainly captured and the sound released more slowly, causing more absorption if compared to the previous version of Zen Panel.

FR

Le marché recherche de plus en plus des produits acoustique à utiliser dans des environnements tels que les restaurants, les salons d'aéroport, les bibliothèques, les clubs sociaux, halls d'hôtel ainsi que dans un environnement de bureau. Le centre d'étude e recherche de la Steelbox a renouvelé la conception de ZEN, proposant un panneau qui s'intègre également dans les espaces où le design n'est pas juste un simple alternative, mais une nécessité.

Le panneau phono-dynamique Zen, conçu avec une nouvelle esthétique qui rappelle vaguement le célèbre design capitonné, allège les lignes les rendant moins plats sans sacrifier l'élégance et la légèreté du matériel. En plus de la conception, les performances d'absorption acoustique ont également été améliorées, grâce aux cavités coniques sur la surface, qui exercent une action de résonateur; les vibrations sont en effet captées dans une plus grande mesure et son libéré plus lentement, entraînant une augmentation de l'absorption par rapport à la version précédente du panneau ZEN.

ES

El mercado busca cada vez más productos de absorción acústica para uso en ambientes tales como restaurantes, salas de aeropuertos, bibliotecas, clubes sociales, lobby de hoteles y en un ambiente de oficina. El Centro de Estudios e desarrollo de Steelbox ha renovado el diseño de ZEN, proponiendo un panel que también cabe en espacios donde el diseño no es solo uno mera alternativa, pero una necesidad.

El panel phono-dinámico Zen, concebido con una nueva estética que recuerda vagamente el famoso diseño capitonné, aligera las líneas haciéndolos menos planos sin sacrificar la elegancia y la ligereza del material. Además del diseño, las prestaciones de absorción de sonido también se han mejorado, gracias a las cavidades cónicas en la superficie, que ejercen una acción resonante; de hecho, las vibraciones se captan en mayor medida y el sonido se libera más lentamente, lo que provoca un aumento de la absorción en comparación a la versión anterior del panel ZEN.

**ALL PANELS**  
PAG. 218

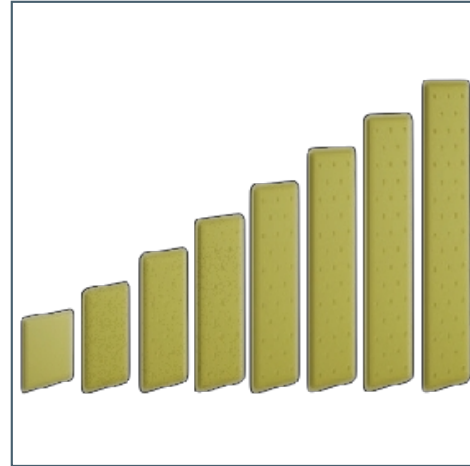

**PRIVACY SUITE**  
PAG. 221



**PRIVACY**  
PAG. 225



**TANGRAM**  
PAG. 231



**WALL AND CRYSTAL**  
PAG. 237



**CEILING**  
PAG. 241



**LIGHTING AND ELECTRICAL**  
PAG. 245



**DESKING AND ACCESSORIES**  
PAG. 249

# ZEN

ALL PANELS

6500 FORME  
6500 SHAPES  
6500 FORMES  
6500 FORMAS

PANEL 59 x 59 cm    PANEL 60 x 40 cm    PANEL 80 x 40 cm    PANEL 100 x 40 cm  
PANEL 120 x 40 cm    PANEL 140 x 40 cm    PANEL 160 x 40 cm    PANEL 180 x 40 cm

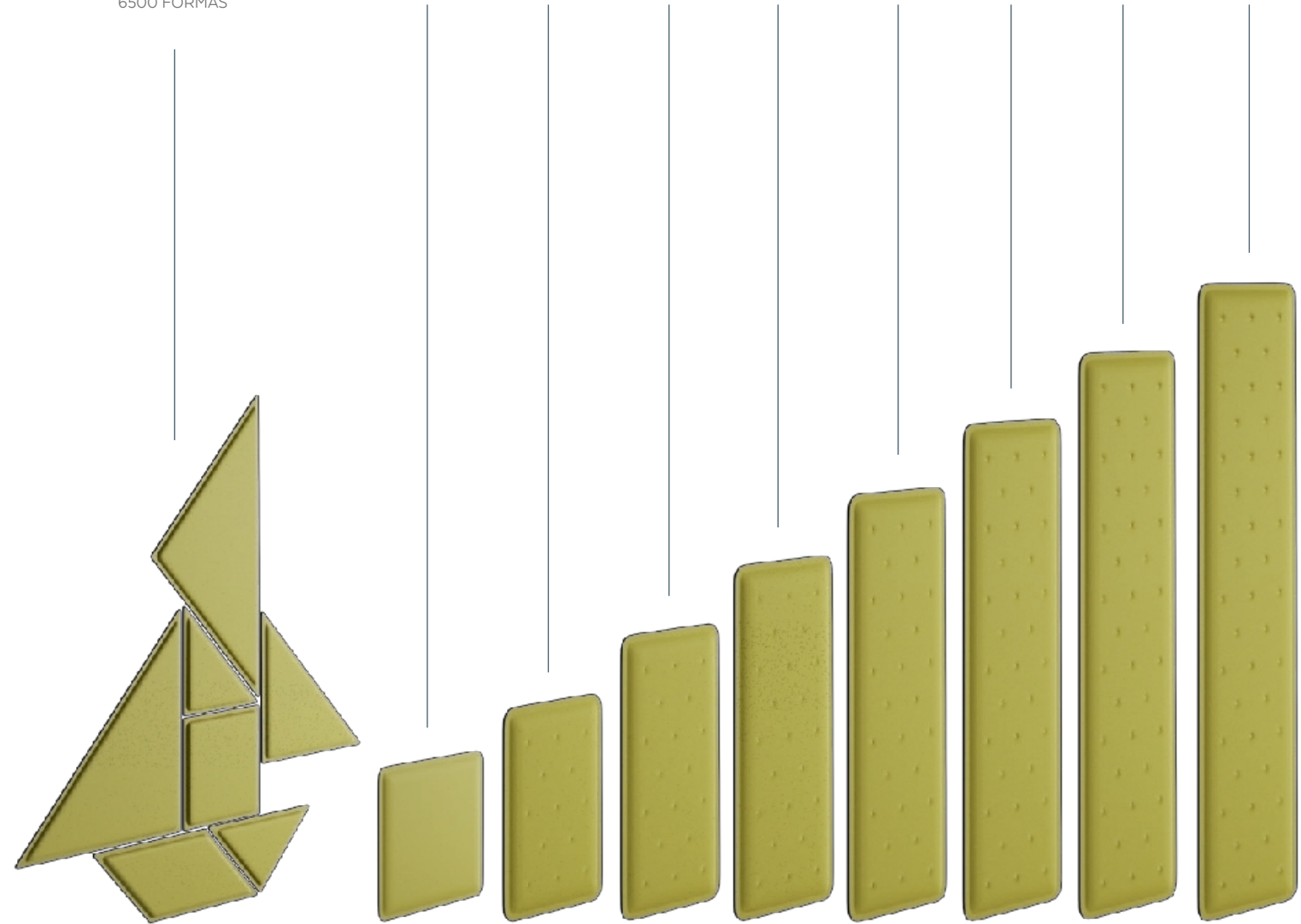

# ZEN

ALL PANELS

LAMPADA CON 2 FARETTI LED A SOSPENSIONE DAL SOFFITTO.  
LED LAMP WITH 2 SPOTS SUSPENDED FROM CEILING.  
LAMPE AVEC 2 SPOTS A LED SUSPENSION DU PLAFOND.  
LÁMPARA CON 2 PROYECTORES LED A SUSPENSIÓN DESDE EL TECHO.

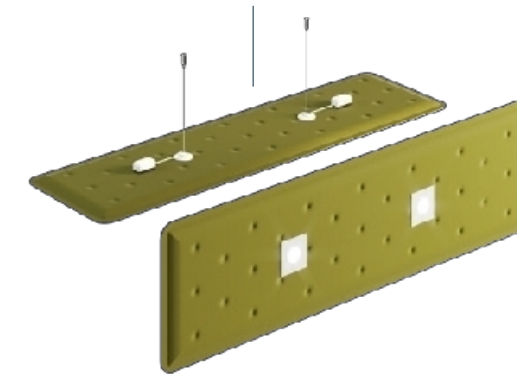

DOUBLE PANEL  
120 x 80 cm  
140 x 80 cm  
160 x 80 cm  
180 x 80 cm

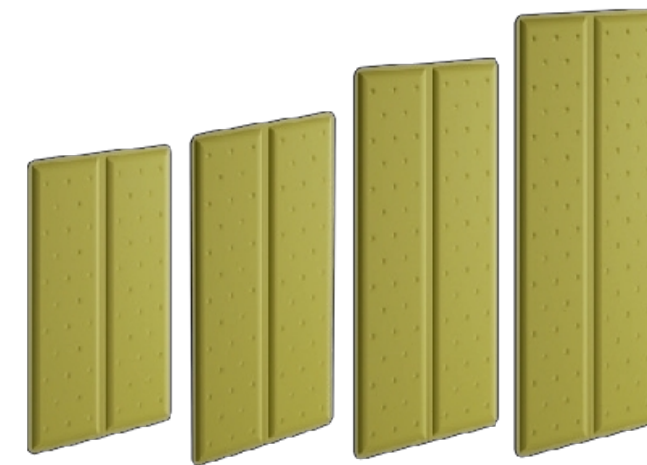

LAMPADA LED LUNGA A SOSPENSIONE DAL SOFFITTO.  
LONG LED LAMP SUSPENDED FROM CEILING.  
LAMPE AVEC 1 LED SPOT A SUSPENSION DU PLAFOND.  
LÁMPARA CON PROYECTOR LED A SUSPENSIÓN DESDE EL TECHO.

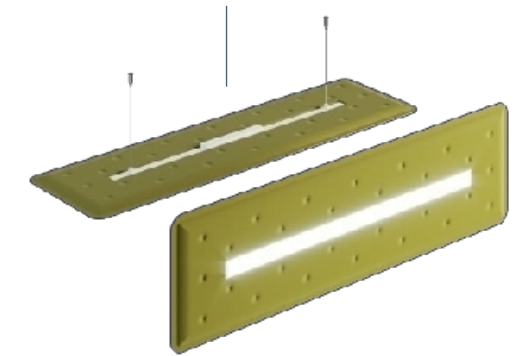

TRIPLE PANEL  
120 x 120 cm  
140 x 120 cm  
160 x 120 cm  
180 x 120 cm



# DESKING AND ACCESSORIES



# ZEN

## DESKING AND ACCESSORIES



MORSETTO PER FRONT PANEL DA  
POSTAZIONE SINGOLA.  
CLAMP FOR SINGLE WORKSTATION  
FRONT PANEL.

PINCE POUR LE PANNEAU FRONTAL  
D'UN POSTE DE TRAVAIL UNIQUE.  
ABRAZADERA PARA EL PANEL FRONTAL  
DE UNA ESTACIÓN DE TRABAJO.



MORSETTO PER BENCH LINEARE.  
FRONT PANEL CLAMPS FOR LINEAR BENCH.  
SUPPORT PANNEAU LATERAL POUR  
BUREAUX PARTAGÉS.

SOPORTE PANEL LATERAL PARA  
ESCRITORIO COMPARTIDOS.

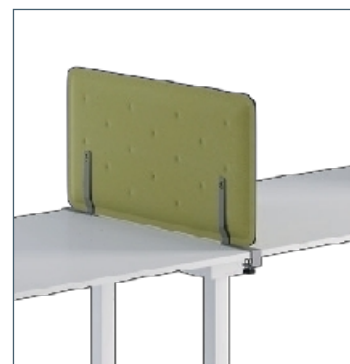

MORSETTO PER LATO ESTERNO  
SOPRA GAMBA.

FRONT PANEL CLAMPS TO USE  
OVER THE SIDE LEG.  
SUPPORT PANNEAU LATERAL  
POUR CÔTÉ EXTERNE.  
SOPORTE PANEL LATERAL  
LADO EXTERNO.

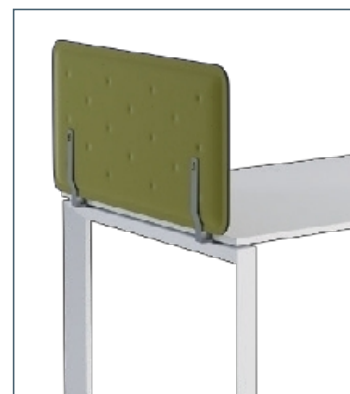

# ZEN

## DESKING AND ACCESSORIES



SUPPORTO PER FRONT PANEL  
POSTAZIONE SINGOLA.

SUPPORT FOR SINGLE WORKSTATION  
FRONT PANEL.

SUPPORT PANNEAU FRONTAL D'UN  
SEUL POSTE DE TRAVAIL.

SOPORTE PANEL FRONTAL DE UNA  
SOLA ESTACIÓN DE TRABAJO.

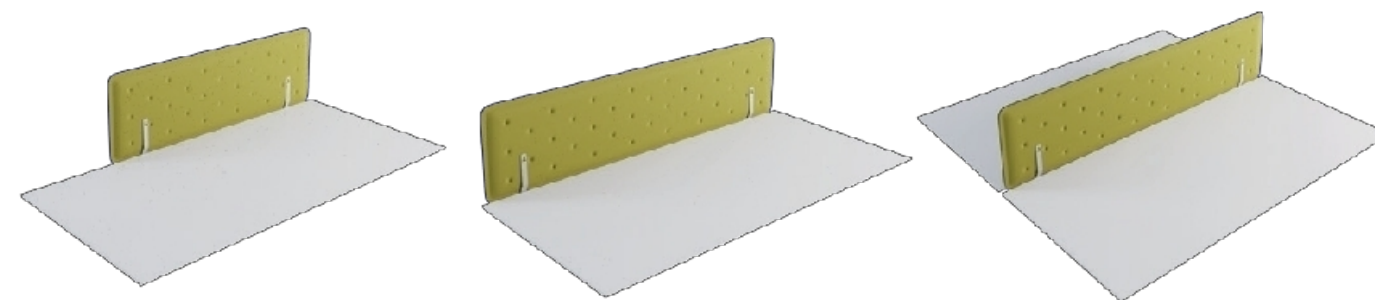
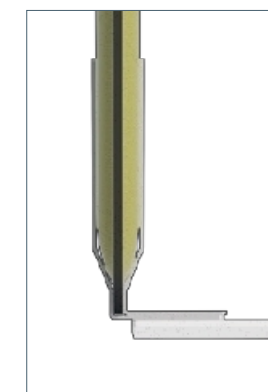
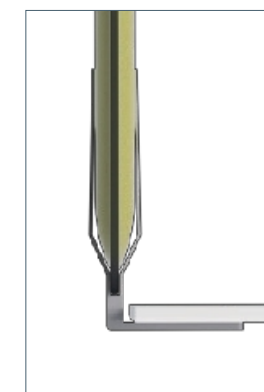

# ZEN

## DESKING AND ACCESSORIES

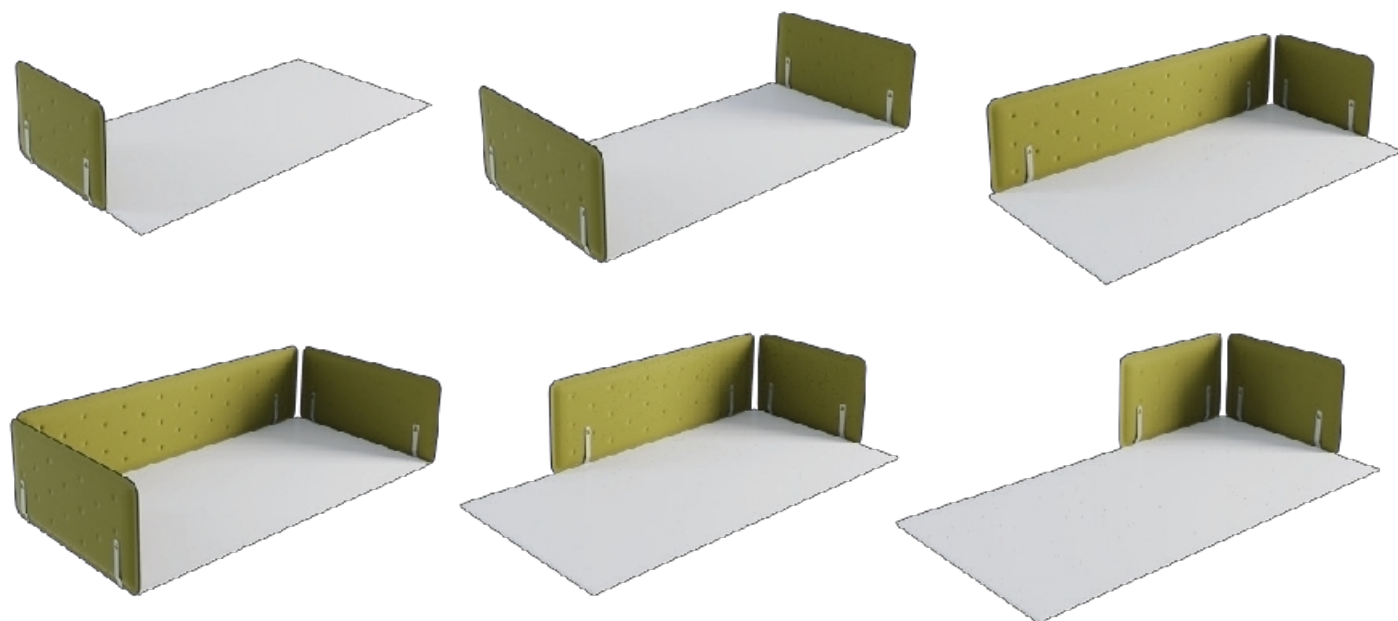

SUPPORTO PER FRONT PANEL  
DA BENCH DESKING.  
SUPPORT FRONT PANEL PER  
BENCH DESKING.  
SUPPORT PANNEAU FRONTAL  
POUR BUREAUX PARTAGÉS.  
SOPORTE PANEL FRONTAL PARA  
ESCRITORIOS COMPARTIDOS.

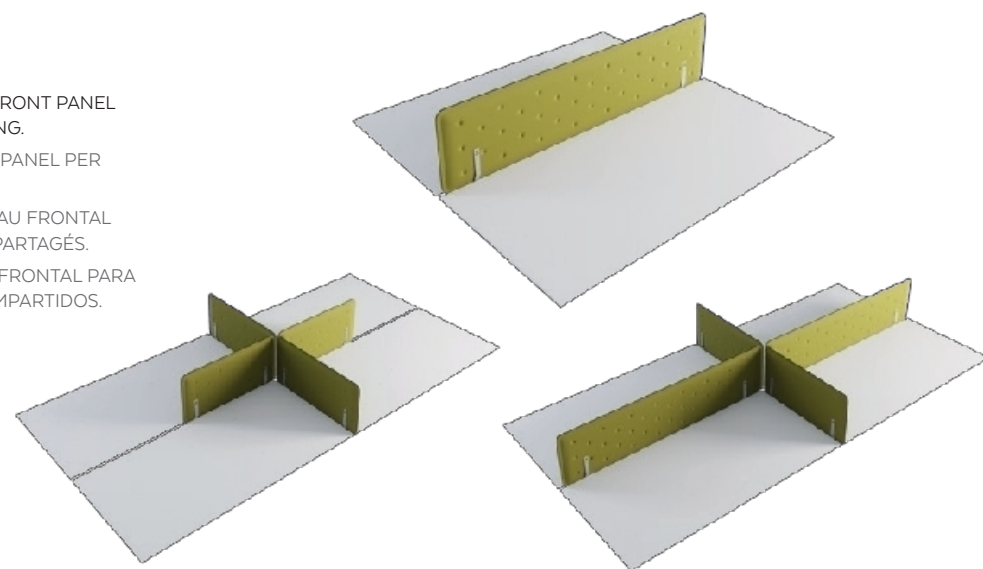

# ZEN

## DESKING AND ACCESSORIES



COPPIA SUPPORTI PER FRONT PANEL  
DA APPOGGIO.  
SET OF 2 BRACKETS FOR PANEL SELF  
SUPPORTING.  
ENSEMBLE DE DEUX SUPPORTS  
AUTONOME POUR LE PANNEAU  
FRONTAL.  
CONJUNTO DE 2 SOPORTES  
AUTONOMOS PARA PANEL FRONTAL.

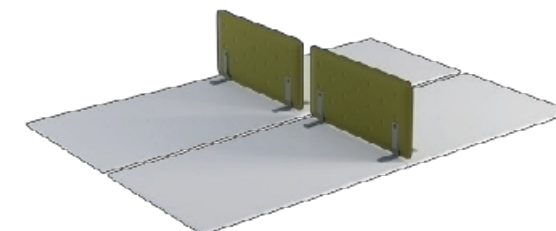

COPPIA SUPPORTI FRONT PANEL  
PER 2 PANNELLI.  
SET OF 2 BRACKETS FOR 2  
DESKING PANELS.  
ENSEMBLE DE SUPPORT POUR 2  
PANNEAUX FRONTAL.  
CONJUNTO DE SOPORTES PARA 2  
PANELES FRONTAL.

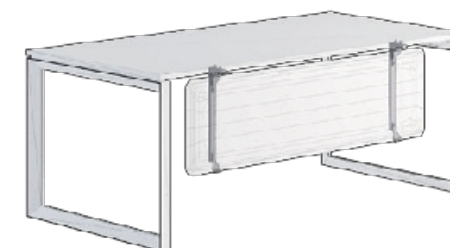

STAFFE PER AGGANCIAMENTO MODESTY PANEL.  
BRACKETS FOR MODESTY PANEL.  
SUPPORTS POUR PANNEAU MODESTY.  
SOPORTES PARA PANEL MODESTY.

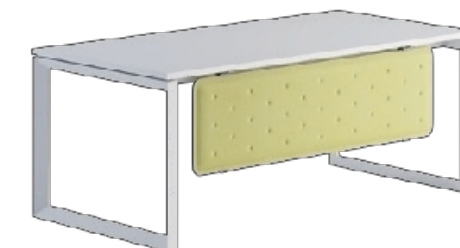

# ZEN

## DESKING AND ACCESSORIES

IL PROFILO DI AGGANCIAMENTO ACCESSORI - BREVETTO METALWAY - OFFRE LA POSSIBILITÀ DI ALLOGGIARE DUE ACCESSORI COMPLANARI AI DUE LATI DEL PANNELLO PERMETTENDO A ENTRAMBI GLI OPERATORI DI USUFRUIRE DI TUTTO LO SPAZIO DISPONIBILE SENZA INTERRUZIONI.

THE EDGE TO HOOK THE ACCESSORIES - PATENTED METALWAY - OFFERS THE POSSIBILITY TO HAVE TWO ACCESSORIES AT TIME IN BOTH SIDES OF THE PANEL ALLOWING BOTH OPERATORS TO TAKE ADVANTAGE OF ALL AVAILABLE SPACE WITHOUT INTERRUPTIONS.

LE DISPOSITIF D'ATTELAGE DES ACCESSOIRES - BREVET METALWAY - OFFRE LA POSSIBILITÉ D'ACCUEILLIR DEUX ACCESSOIRES ADJACENTS DES DEUX CÔTÉS DU PANNEAU EN PERMETTANT AUX DEUX OPÉRATEURS DE PROFITER DE TOUT L'ESPACE DISPONIBLE SANS INTERRUPTIONS.

EL PERFIL DE ENGANCHE DE LOS ACCESORIOS -PATENTE METALWAY - OFRECE LA POSIBILIDAD DE ALOJAR DOS ACCESORIOS COPLANARES POR LOS DOS LADOS DEL PANEL, LO QUE PERMITE A AMBOS OPERADORES DISFRUTAR TODO EL ESPACIO DISPONIBLE SIN INTERRUPCIONES.



# ZEN

## DESKING AND ACCESSORIES

VASCHETTA A4.  
PAPER TRAY A4.  
CORBEILLE A4.  
BANDEJA A4.



SUPPORTO TABLET.  
TABLET STAND.  
SUPPORT TABLET.  
PORTA TABLET.



LAVAGNA METALLICA.  
METALLIC BOARD.  
TABLEAU.  
PIZZARRA.



SUPPORTO CELLULARE.  
SMARTPHONE STAND.  
CHAUSSETTE DE PORTABLE.  
SOPORTE PARA EL TELÉFONO.



KIT 2 GANCI APPENDIABILI.  
SET OF 2 CLOTH HANGERS.  
ENSEMBLE DE 2 CINTRES.  
CONJUNTO DE 2 PERCHAS.



PORTA PENNE.  
PEN HOLDER.  
PORTE-STYLOS.  
PORTA LAPICES.



PORTA BOTTIGLIE  
BOTTLE HOLDER.  
PORTE-BOUTEILLES.  
SOPORTE PARA BOTELLAS.



PORTA FIORI.  
FLOWER STAND.  
PORTE-FLEURS.  
SOPORTE PARA FLORES.



FIORIERA PER PANNELLI.  
PLANTER FOR PANELS.  
PLANTEUR POUR PANNEAU.  
FLORERO PARA PANEL.

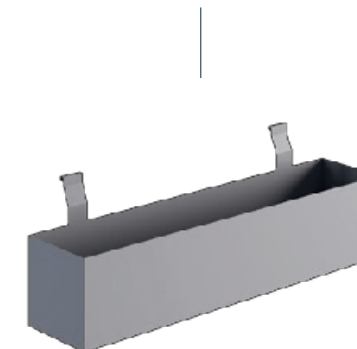

## ZEN

### DESKING AND ACCESSORIES

GANCIO PORTABORSE.  
BAG HOOK.  
SUPPORT DE SAC.  
GANCHO PORTABOLSAS.

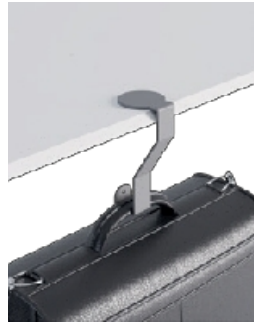

PORTA MONITOR.  
MONITOR STAND.  
SUPPORT PARA MONITEUR.  
SOPORTE PARA PANTALLA.



MULTIPRESA USB PER 6 DISPOSITIVI.  
6 DEVICES USB MULTICHARGER.  
USB MULTI-CHARGE POUR 6 APPAREILS.  
USB MULTICARGA PARA 6 DISPOSITIVOS.



LAMPADA A LED DA SCRIVANIA POTENZA 6 W.  
6 W POWER LED DESK LAMP.  
LAMPE DESKING A LED POWER 6 W.  
LÁMPARA A LED DESKING POWER 6W.

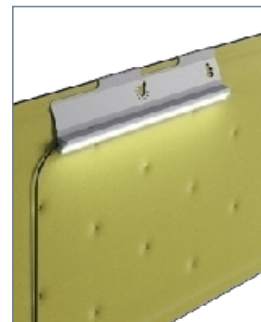

## COLORI DEI TESSUTI

### FABRIC COLORS | COULEUR DES TISSUS | COLORES DE LA TELAS



**GIALLO**  
Yellow | Jaune | Amarillo  
cod. 0053



**ARANCIO**  
orange | orange | naranja  
cod. 0120



**ROSSO**  
Red | Rouge | Rojo  
cod. 0231

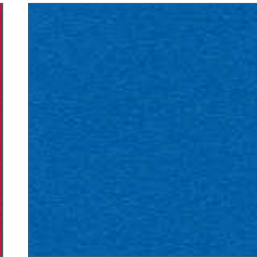

**BLU**  
Blue | Bleu | Azul  
cod. 0331



**CELESTE**  
Light blue | Céleste | Celeste  
cod. 0379



**VERDE ACIDO**  
Green | Vert | Verde  
cod. 0426



**AVORIO**  
Ivory | Ivoire | Marfil  
cod. 0532



**NOCCIOLA**  
Light Brown | Noisette | Avellana  
cod. 0534

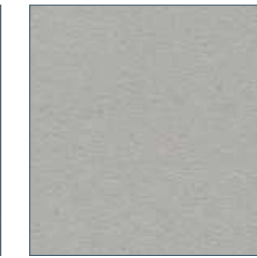

**GRIGIO PERLA**  
Light Grey | Perle grise | Gris Claro  
cod. 0643



**NERO**  
Black / Noir / Negro  
cod. 0651

## COLORI DEI METALLI

### METAL SAMPLE COLORS | COULEURS DES METAUX | COLORES DEL LOS METALES



**BIANCO**  
White | Blanche | Blanco  
cod. 9003

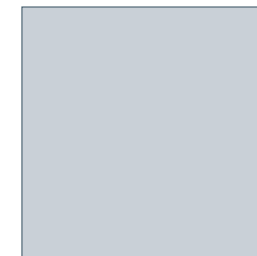

**GRIGIO**  
Grey | Gris | Gris  
cod. 7035



**ANTRACITE**  
Anthracite | Anthracite | Antracita  
cod. 7016