

SCHEMA TECNICA**Scrivanie e tavoli**

I piani della scrivania e dei tavoli sono realizzati in MDF sp 22 mm con sagomatura perimetrale e sono rivestiti con pellicola termoformabile nella parte superiore mentre la parte inferiore è in melaminico bianco o nero oppure in gres porcellanato sp.12 mm.

Le gambe sono realizzate in MDF sp 22 mm sagomate sul lato lungo e sono rivestite con pellicola termoformabile dello stesso colore da tutte e due i lati, oppure in metallo con forma ellittica sezione 60x30 verniciato a polveri epossidiche.

I tavoli riunione sono dotati di top access ad apertura bifacciale; come optional sono disponibili dei kit prese configurabili con Shuko EU, FR o GB e connettori RJ45, USB o HDMI.

I tavoli riunione sono canalizzati nella parte inferiore tramite il tunnel centrale che permette il passaggio e la raccolta cavi; è realizzato in pannello nobilitato CARB P2 sp 18 mm ed ha la funzione di struttura portante.

Nei tavoli con 3 gambe, la salita dei cavi avviene attraverso la gamba centrale che è ispezionabile lateralmente.

Mobile di servizio

Coperchio, fondo e schiena sono realizzati in nobilitato CARB P2 sp 18 mm. I moduli interni sono realizzati in melaminico sp 18 mm nei colori come da campionario.

Credenza

Coperchio, fondo e schiena sono realizzati in nobilitato CARB P2 sp 18 mm.

I piedini sono realizzate sempre in nobilitato CARB P2 sp 18 mm sagomati sul lato lungo.

I moduli interni sono realizzati in melaminico sp 18 mm nei colori come da campionario.

Le ante sono ad apertura push & pull.

TECHNICAL SHEET**Desks and tables**

Desk and table tops are made of MDF th. mm 22 with shaped perimeter and covered with thermoformed foil on the topside and white or black melamine underside or in porcelain tile th. 12 mm.

Legs are made of MDF th. mm 22, shaped on the long side and covered with thermoformed foil same color on both sides.

Meeting tables are provided with top access double-sided opening.

As optional, kit sockets configurable with Schuko EU, FR or GB and connectors RJ45, USB or HDMI are available.

Meeting tables are ducted underside with a central tunnel for cables passage and collection.

The tunnel is made of melamine panel th. mm 18 and it has also the function of supporting structure.

In the meeting tables with three legs rise of cables through central leg that is inspectable sideways.

Service unit

Top, bottom and back are made of melamine CARB P2 th. mm 18.

Inside elements are made of melamine th. mm 18 with colors available in our collection.

Cupboard

Top, bottom and back are made of melamine CARB P2 th. mm 18.

Legs are made of melamine CARB P2 th. mm 18 shaped on the long side.

Inside elements are made of melamine th. mm 18 with colors available in our collection.

Doors are provided with push-pull opening.

FICHE TECHNIQUE**Bureaux et tables**

Les plateaux des bureaux et des tables sont réalisés en MDF ép. mm 22 avec périmètre modelé et revêtus avec feuille thermoformée sur la partie supérieure et mélamine ép. mm 18 blanc ou noir sur la partie inférieure et in gres porcelaine.

Les pieds sont réalisés en MDF ép. mm 22, modelés sur le côté long et revêtus avec feuille thermoformée de la même couleur sur les deux côtés.

Les tables de réunion sont équipées de top access double face.

Kit prises configurables avec Schuko EU, FR ou GB et connecteurs RJ45, USB ou HDMI sont disponibles en option.

Les tables de réunion sont canalisées dans la partie inférieure par un tunnel central qui permet le passage et la collecte des câbles.

Le tunnel est réalisé en mélamine ép. mm 18 et il a aussi la fonction de structure porteuse.

Dans les tables avec 3 pieds la collecte des câbles se fait par le pied central qui est inspectable sur le côté.

Meubles de service

Top, fond et dos sont réalisés en melaminè CARB P2 ép. mm 18.

Les éléments intérieurs sont réalisés en mélamine ép. mm 18 avec les couleurs disponibles dans notre collection.

Buffet

Top, fond et dos sont réalisés en melaminè CARB P2 ép. mm 18.

Les pieds sont réalisés en melaminè CARB P2 ép. mm 22 modulés sur le côté long.

Les éléments intérieurs sont réalisés en mélamine ép. mm 18 avec les couleurs disponibles dans notre collection.

Les portes ont l'ouverture push-pul.

**TECHNISCHE UNTERLAGE**

Die Schreibtischplatten und die Tischplatten bestehen aus MDF dicke mm 22 mit geformten Rand und sind mit thermogeformte Folie am oberen Teil und mit weisse oder schwarze Melamin am unteren Teil beschichtet oder aus feinsteinzeug dicke 112 mm.

Die Füße bestehen aus MDF dicke mm 22 mit geformte lange Seite und sind mit thermogeformte Folie derselben Farbe auf beiden Seiten beschichtet.

Die Konferenztische verfügen über Top Access mit doppelte Öffnung.

Als Option sind Kit Steckdosen zur Verfügung, die mit Schuko EU, FR oder GB und Stecker RJ45, USB oder HDMI konfigurierbare sind.

Die Konferenztische verfügen über Kabelkanal am unteren Teil für Kabelführung und -sammmlung. Der Kabelkanal besteht aus Melamin dicke mm 18 und er ist Teil der tragende Struktur.

Der Kabelkanal für die Konferenztische mit 3 Füße ist der zentrale Fuss, den seitlich besichtigbar ist.

Multifunktionelement

Top, Boden und Rücken bestehen aus MDF dicke mm 18 und sind mit thermogeformte Folie auf beiden Seiten beschichtet.

Die innere Elemente bestehen aus Melamin dicke mm18 mit die Farben wie zum Collection.

Schrank

Top, Boden und Rücken bestehen aus melamin CARB P2 dicke mm 18.

Die Füße bestehen aus melamin CARB P2 dicke mm 18.

Die innere Elemente bestehen aus melamin CARB P2 dicke mm18 mit die Farben wie zum Collection.

Die Türen sind mit push-pull Öffnung.

FICHA TECNICA**Escritorios y mesas**

Los tableros de las escritorios y las mesas se realizan en MDF espesor mm 22 con perimetro moldeado y estan recubiertos con pelicula termoformada en la parte superior mientras que la parte inferior es de melamina blanco o negro y gres porcelanico es. 12 mm.

Las patas se realizan en MDF moldeados en el lado largo y estan recubiertos con pelicula termoformada del mismo color en ambos lados.

Las mesas de reunion estand equipadas con top access con puerta de pelicula termoformada del mismo color que el tablero con abertura bifacial.

Como opcion estand disponibles kits de tomas configurables con Schuko EU, FR o GB y conectores RJ45, USB o HDMI.

Las mesas de reunion se canalizaran en la parte inferior a traves un tunnel central que permite el paso y la recoleccion de los cables.

El tunnel se realiza en melamina espesor mm 18 y tiene la funcion de la estructura de soporte.

En las mesas de tres patas la subida de los cables se realiza a traves de la pata central que se puede inspeccionar lateralmente.

Mueble de servicio

Tapa, parte inferior y parte posterior se realizan en melamina CARB P2 espesor mm 18.

Los modulos internos se realizan en melamina CARB P2 espesor mm 18 en los colores segun el muestrario.

Armario

Tapa, parte inferior y parte posterior se realizan en melamina CARB P2 espesor mm 18.

Las patas se realizan en melamina CARB P2 espesor mm 22 moldeado en el lado largo.

Los modulos internos se realizan en melamina espesor mm 18 en los colores segun el muestrario.

Las puertas son de abertura push-pull.



TERMOFORMATO

THERMOFORMED FINISHES / FINITIONS THERMOFORMÉES



PV541

OLMO LIGHT
LIGHT ELM / OLME LIGHT
LEICHTE ULME / OLMO CLARO

MELAMINICO CARB P2

MELAMINE CARB P2 / MELAMINE CARB P2 / MELAMIN CARB P2 / MELAMINICO CARB P2

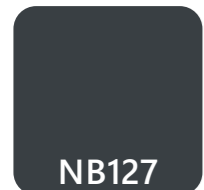

NB127

ANTRACITE
ANTHRACITE / ANTHRACITE
ANTHRAZIT / ANTRACITA



NB130

TORTORA
DOVE GREY / TAUPE
TAUBENGRAU / PALOMA

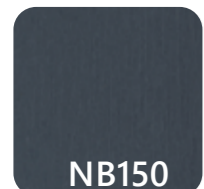

NB150

BLU INTENSO
DEEP BLUE / BLEU INTENSE
TIEFBLAU / AZUL INTENSO



NB151

CERULEO
CERULEAN BLUE / BLEU CÉRULÉEN
HIMMELBLAU / AZUL CERÚLEO



NB152

CARTA DA ZUCCHERO
LIGHT BLUE / BLEU CIEL
HELLBLAU / AZUL



NB155

SALVIA
SAGE / SAUGE
SALBEI / SALVIA

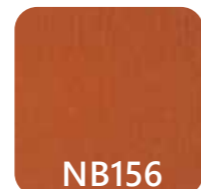

NB156

ARAGOSTA
LOBSTER ORANGE / ORANGE ÉCREVISSE
HUMMERORANGE / NARANJA LANGOSTA

METALLO

METAL / METAL / METALL / METAL

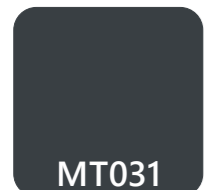

MT031

ANTRACITE
ANTHRACITE / ANTHRACITE
ANTHRAZIT / ANTRACITA



MT130

TORTORA
DOVE GREY / TAUPE
TAUBENGRAU / PALOMA



MT084

CURRY
CURRY / CURRY
CURRY / CURRY



MT037

OLIVA
OLIVE / OLIVE
OLIVE / OLIVA



MT150

BLU INTENSO
DEEP BLUE / BLEU INTENSE
TIEFBLAU / AZUL INTENSO



MT151

CERULEO
CERULEAN BLUE / BLEU CÉRULÉEN
HIMMELBLAU / AZUL CERÚLEO



MT152

CARTA DA ZUCCHERO
LIGHT BLUE / BLEU CIEL
HELLBLAU / AZUL



MT155

SALVIA
SAGE / SAUGE
SALBEI / SALVIA



MT156

ARAGOSTA
LOBSTER ORANGE / ORANGE ÉCREVISSE
HUMMERORANGE / NARANJA LANGOSTA

GRES PORCELLANATO

PORCELAIN TILE / GRÈS PORCELAINÉ / FEINSTEINZEUG / GRES PORCELÁNICO

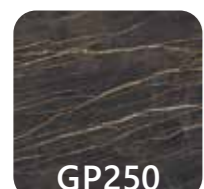

GP250

NOIR DESIR



GP255

CALACATTA

FINISHING / FINITIONS / FARBE / ACABADOS

C1

C2

C3

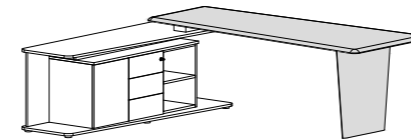

PV541

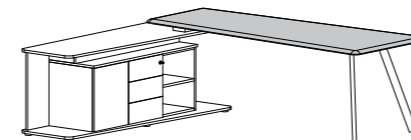

PV541



GP250



GP255

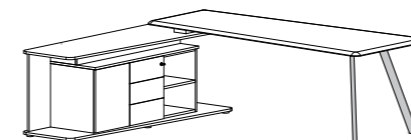

MT031



MT130



MT084



MT037



MT150



MT151



MT152



MT155



MT156

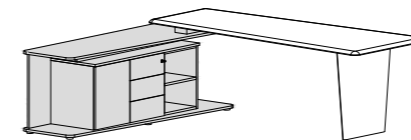

NB127



NB130



NB155



NB156



NB150



NB151



NB152



C1

C2

C3

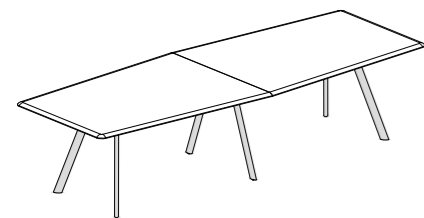
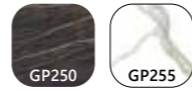
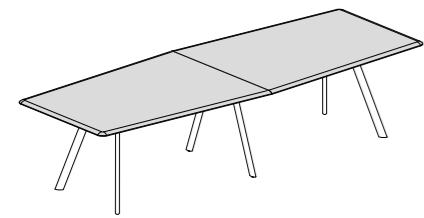
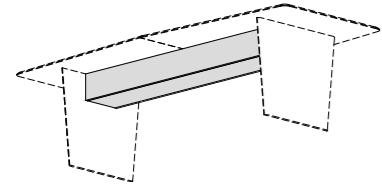
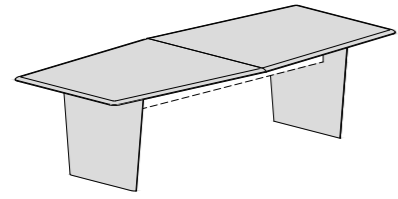

C1

C2

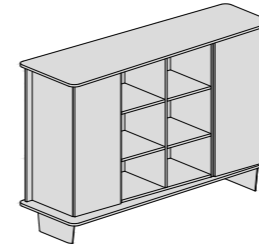

SHAPE



TECHNICAL SCHEME / SCHÉMA TECHNIQUE
TECHNISCHE ZEICHNUNG / ESQUEMA TÉCNICO

SCRIVANIA CON MOBILE DI SERVIZIO

Desk with service unit / Bureau avec meuble service

Schreibtisch mit multifunktion element/ Escritorio con mueble de servicio

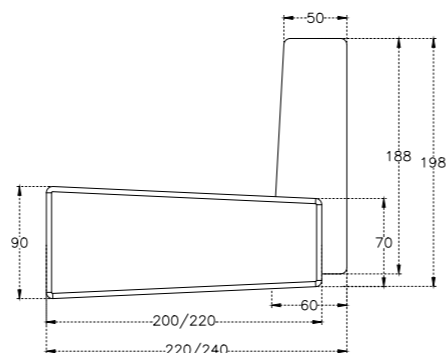
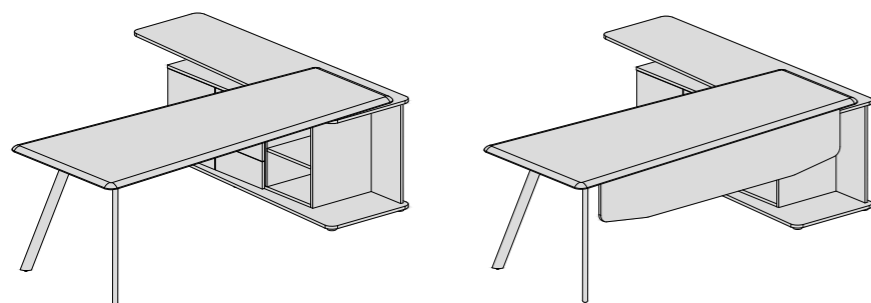
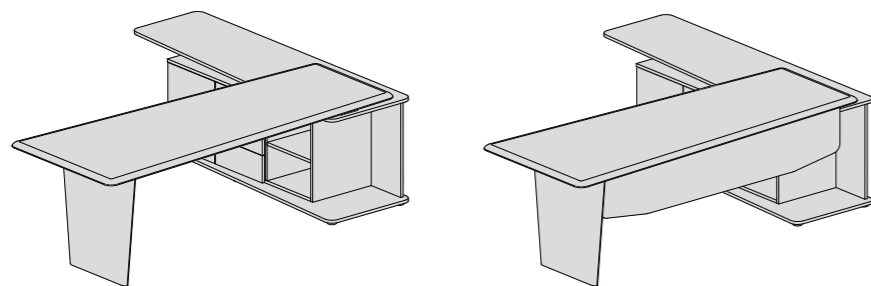

CREDENZE

Cupboards / Buffet
Schrank / Armario

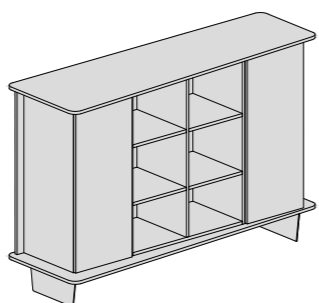
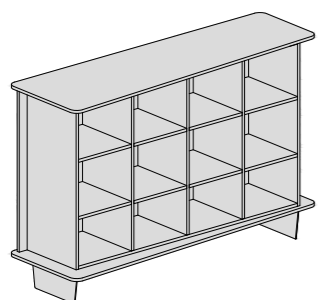
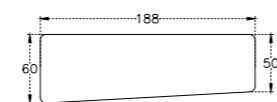
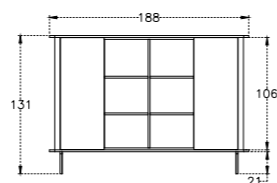
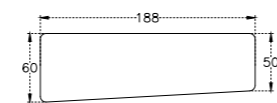
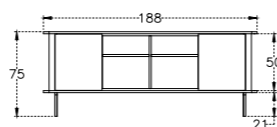
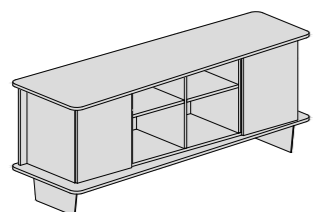

TECHNICAL SCHEME / SCHÉMA TECHNIQUE
TECHNISCHE ZEICHNUNG / ESQUEMA TÉCNICO

TAVOLI RIUNIONE

Meeting tables / Tables de réunion

Konferenz Tisch / Mesas de reunion

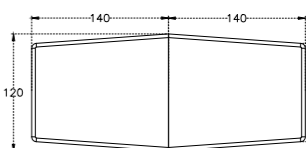
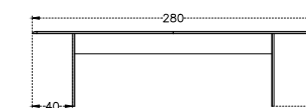
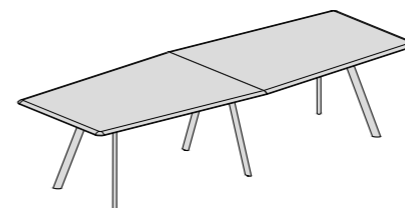
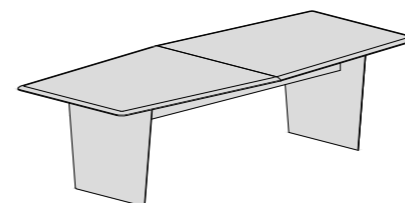

TAVOLI RIUNIONE

Meeting tables / Tables de réunion

Konferenz Tisch / Mesas de reunion

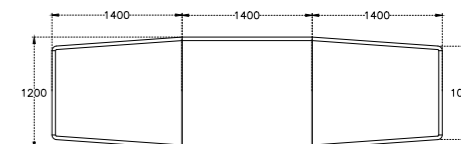
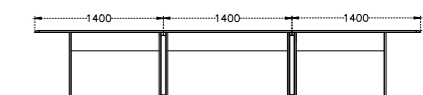
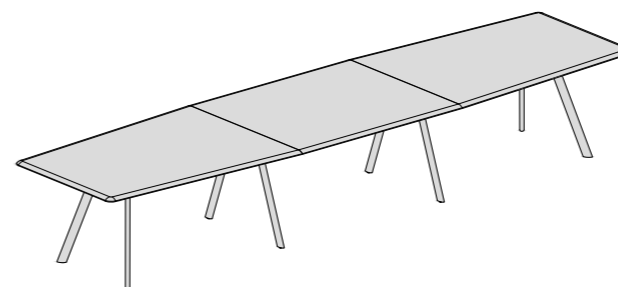
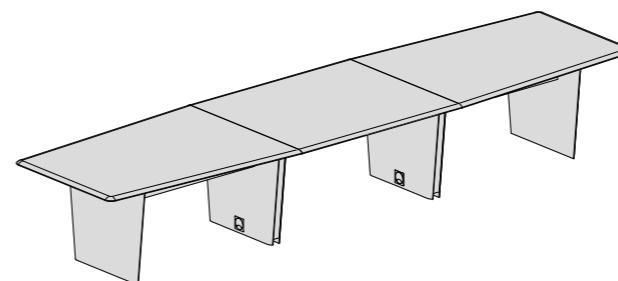

MODULO INTERMEDIO

Intermediate module / Élément intermédiaire
Zwischenelement / Elemento intermedio

